

**391999 (E9PCPDRMC0)**

Electric Freestanding Rethermalizer, 1 Well - 40 litres - 240 V

**Main Features**

- Easy to use electronic control panel with LED display showing water temperature and re-therm cycle countdown. An acoustic alarm warns the operator when the cycle is completed.
- Two program cycles available: - Default re-therm program: the cycle allows the re-thermalization of minimum 2 and up to a maximum of 10 bags of soup from 5°C to 80°C in 60 minutes (at an ambient temperature of 20°C. Times may vary depending on soup and bag type as well as bag temperature from fridge). - Searing program: allows the operator to extend the re-therm cycle for additional 10 minutes, if a higher temperature is required.
- When launching a cycle, if the water is below 75° C the unit will display "PrEh" and the countdown will start once the temperature of 75° C is achieved.
- Well equipped with a dedicated temperature sensor to control the water temperature and 3 additional sensors to manage the water level.
- Overflow sensor detects if the water exceeds the maximum level and automatically activates the drainage pump connected to the overflow pipe.
- Safety thermostat prevents the machine from running without water.
- Automatic water level filling and re-filling.
- Well equipped with 2 dedicated AISI 304 stainless steel racks, able to fit 5 bags each (10 bags totally). The racks have a flexible wall to maintain the correct bag position during the cycle, thus guaranteeing maximum performances.

**Construction**

- IPx4 water protection.
- Water basin in 316-L type Stainless steel to avoid corrosion.
- One piece pressed 1.5 mm worktop in stainless steel with smooth, rounded corners.
- Exterior panels in stainless steel with Scotch Brite finish. Back, bottom and front made in stainless steel.
- Stainless Steel removable support located inside the well to support the soup bags.
- Infrared heating system positioned under the external base of the well to ensure elevated performances.
- Safety thermostat automatically switches off the appliance in case of overheating.
- Rear hinged swiveling cover and handle with spring torsion mechanism to allow the cover to remain open during operations.
- Water drain positioned on the back of the appliance with an external flexible pipe to facilitate well discharging.
- Integrated water drain pump to manage draining operations and water overflow.
- Mounted on 200 mm high feet.
- Equipped with 2 meter cable with plug.



## Optional Accessories

PNC Code	Description
<b>Kicking strips</b>	
206177	Frontal kicking strip, 1000mm (not for refr-freezer base)

## Recommended Detergents

PNC Code	Description
OS2292	C41 HI-TEMP RAPID DEGREASER, 1 pack of six 1 lt bottles (trigger incl.)
OS2881	S01 STAINLESS STEEL SURFACE POLISHER; 6 BOTTLES X 750ML C/T
OS2882	S02 Degreaser for ovens and SpeedDelight. Specific for cleaning the cooking chambers of GourmeXpress and SpeeDelight. Active up to a maximum of 50°C Complete with spray bottle Pack of 6 750ml bottles
OS2883	S03 ALCOHOL BASE DETERGENT; 6 BOTTLES X 750ML; ADR&IMDG&IATA Limited Quantity
OS2884	S04 GLASSES & HARD SURFACES CLEANERS; 6 BOTTLES X 750ML
OS3257	S05 - MULTIPURPOSE DEGREASER; 6PCS X 750ML; ADR&IMDG Limited Quantity



# Technical specifications

## Electric

Supply voltage:	220-240 V/1 ph/50 Hz
Total Watts:	3.5 kW

## Water:

Incoming Cold/hot Water line size:	3/4"
Drain line size:	3/4"

## Key Information:

Number of wells:	
Usable well dimensions (width):	300 mm
Usable well dimensions (height):	260 mm
Usable well dimensions (depth):	510 mm
Well capacity:	22 lt MIN; 40 lt MAX
Thermostat Range:	85 °C MIN; 95 °C MAX
External dimensions, Width:	400 mm
External dimensions, Depth:	933 mm
External dimensions, Height:	850 mm
Shipping weight:	68 kg
Shipping height:	1080 mm
Shipping width:	460 mm
Shipping depth:	1020 mm
Shipping volume:	0.51 m <sup>3</sup>
Configuration:	Free Standing
Approvals	CE;CB;WRAS
Certification group:	N9RT

## Front

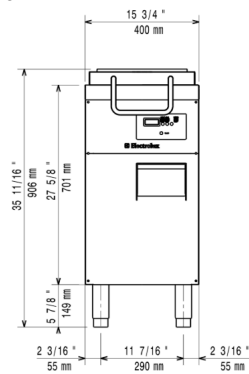

## Side

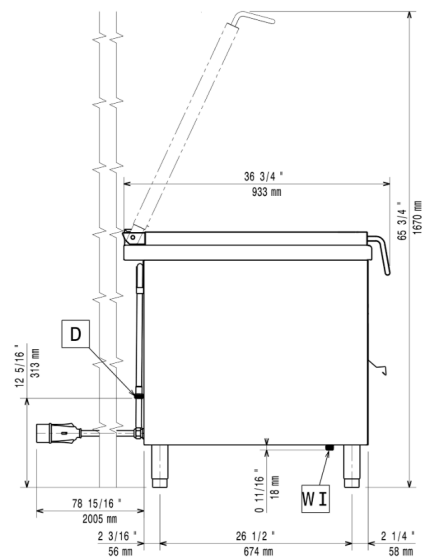

## Top

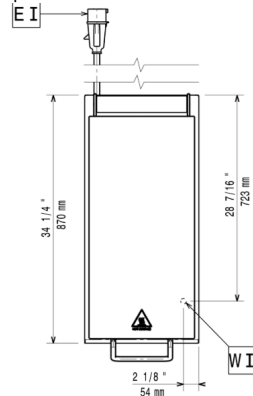

- D = Drain
- EI = Electrical inlet (power)
- EQ = Equipotential screw
- DO = Overflow drain pipe



Find out more:  
ISO Certificates  
Electrolux Professional Recognitions

The company reserves the right to make modifications to the products without prior notice. All information correct at time of printing.

2026/04/08